



owner's manual

Dear rider,

First of all we wish to thank you for choosing this motorcycle of our production.

By following all instructions outlined in this manual you will ensure your bike a long and troublefree life.

Before riding, please read thoroughly this manual in order to know your motorcycle's features and how to operate it safely.

All major checking and overhauling jobs are best carried out by our dealers who have the necessary facilities to quickly and competently repair your Moto Guzzi.

Repairs or adjustments made by others than Guzzi dealers during the warranty period could invalidate the warranty right.

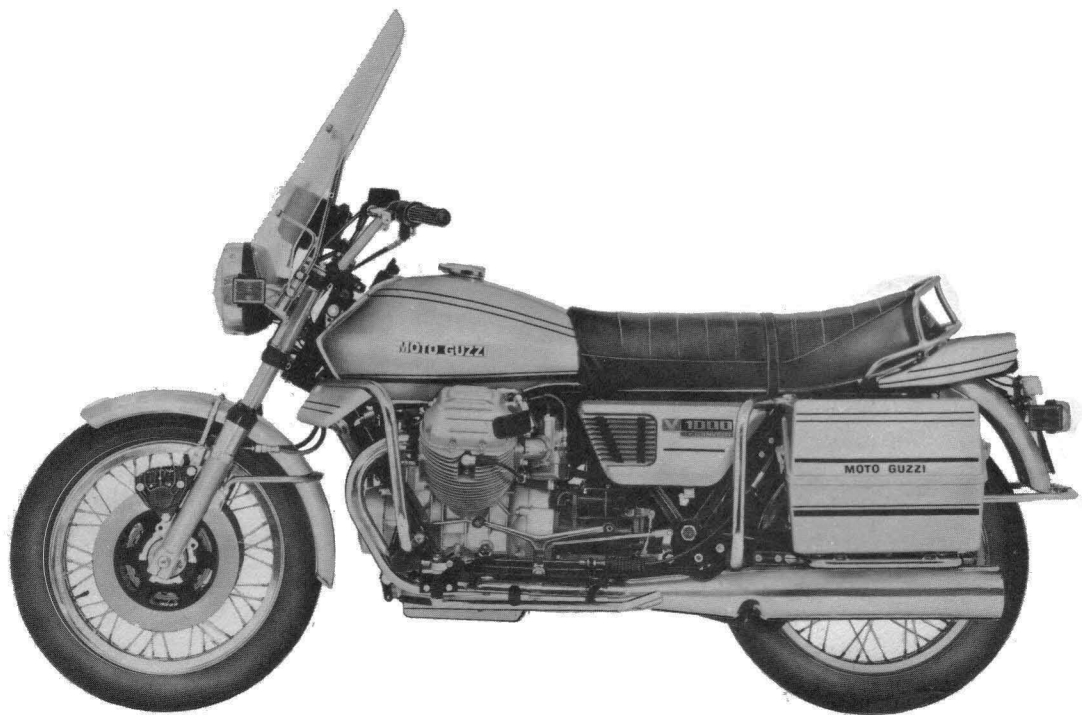

INDEX

- 5 Main features
- 12 Controls and accessories
- 14 Identification data
- 14 Spare parts
- 14 Warranty
- 15 Instruments and controls
- 22 Riding instructions
- 25 Running in
- 26 Maintenance and adjustments
- 33 Removal of wheels
- 36 Lubrication and maintenance chart
- 40 Lubrication
- 45 Carburetion
- 48 Valve gearing
- 49 Ignition
- 52 Electrical equipment
- 56 Changes for U.S.A. Police model «LAPD»
- 58 Maintenance and adjustments
 - Wiring diagram (U.S.A. model)
 - Wiring diagram (U.S.A. Police model)

MAIN FEATURES

Engine

2-cylinder 4-stroke
Cylinder disposition «V» 90°
Bore mm 88
Stroke mm 78
Displacement cc 948,8
Compression ratio 9,2 : 1
Right max. horsepower HP 71 SAE at 6500 r.p.m.

Valve gearing

O.H.V., push rod operated.
Normal rocker clearance, by cold engine;
inlet and exhaust mm 0,22 (.0086").

Carburetion

N. 2 Dell'Orto carburetors VHB 30 CD (right),
VHB 30 CS (left).

Lubrication

Pressure, by gear pump.
Wire gauze and cartridge filters in oil sump.
Normal lubrication pressure 3,8 ÷ 4,2 kg/sqcm
(54-60 p.s.i.).
Controlled by pressure relief-valve.

Generator-Alternator

Front, on the crankshaft (14 V - 20 A).

Ignition

By battery. with double contact breaker and automatic advance.

Ignition data:

- initial advance (fixed) 2°
- automatic advance 31°
- full advance (f. + a.) 33°
- contact breaker gap mm 0,37 ÷ 0,43
(.014" ÷ .016")
- spark plugs: Marelli CW 7 L and CW 7 LP
Bosch W 225 T2
Champion N 9 Y
- plug points gap mm 0,6 (.023")
- 2 ignition coils.

Starting

Electric starter (12 V - 0,7 HP) with electromagnetic ratchet control. Ring gear bolted on the flywheel. Starter button (START) on the right side of handlebar.

Transmissions**Hydraulic converter**

Type «SACHS», allowing the motorcycle to be started without any clutching.

Max. converting ratio 1,60 : 1.

Clutch	Dry type, multiplate. Hand controlled by lever on the left side of handlebar.	7
Primary drive	By gears. Ratio: $1/1,157$ ($Z = 19/22$).	
Gear box	Two speed, foot operated from the left side of the bike. Gear ratio: first gear ($Z = 18/24$) 1 : 1,333 2nd gear ($Z = 22/22$) 1 : 1	
Secondary drive	By cardan shaft, bevel gear set. Ratio: ($Z = 9/34$) 1 : 3,788 Overall ratio (engine-wheel). 1st gear (Low) 1 : 6,12 2nd gear (Drive) 1 : 4,58	
Frame	Duplex cradle, tubular structure.	
Wheels	Spoked rims, WM 3/2,15 - 18" front and rear.	

Tyres

Front and rear: 4,10 H 18" or 110/90 H 18".

Tyre pressure:

front, solo or with pillion 2,1 kg/sqcm (31 p.s.i.)

rear, solo 2,4 kg/sqcm (32 p.s.i.)

with pillion 2,6 kg/sqcm (38 p.s.i.)

The above data is suggested for normal riding (cruising speed).

If using the motorcycle at constant high speed, or on high ways, it is recommended to increase pressure by 0,2 kg/sqcm (3 p.s.i.).

Brakes**Front wheel.**

Twin disc brake, two independent controls with hydraulic hoses and double cylinder calipers.

Controls.

Right front brake, hand controlled by means of the lever joined to master cylinder on the right handle bar.

Left front brake, foot controlled together with rear brake.

Disc \varnothing mm 300.

Cylinder \varnothing mm 38.

Master cylinder \varnothing mm 12,7.

Rear wheel.

Disc brake, foot controlled from the right side of the motorcycle, hydraulic hose and double cylinder caliper.

Rear brake and left front brake are connected through hydraulic circuit. Both brakes are actuated by same pedal on the right side of the motorcycle.

Disc \varnothing mm 242.

Cylinder \varnothing mm 38.

Master cylinder \varnothing mm 15,875.

Parking brake.

Mechanical brake, acting on hydraulic rear wheel brake. The load given by a parked vehicle on its side stand comes to block up the rear braking disc through a lever transmission system.

Dimensions and weights

Wheelbase	m 1,470	(58")
Max. length	m 2,200	(86,5")
Max. width	m 0,850	(33")
Max. height	m 1,100	(46")
Min. ground clearance	m 0,150	(6")
Curb weight (without accessories)	kg 261	(572 lbs.) approx.

Performances

Maximum speed in each gear, solo riding.	
1st gear (Low)	km/h 130 (82 mi./h)
2nd gear (Drive)	km/h 174 (108 mi./h)
Fuel consumption	l 6 a. x 100 km (approx. 35 m.p.g.)

Fuel and oil capacities

Group or part	Quantities	Recommendation
Fuel tank	24 l (6.6 U.S. gls)	Petrol 98/100 NO-RM
Reserve (warned by light)	4 l (1.0 U.S. gls)	
Engine oil sump	3 l (approx. 3 qts.)	Oil Agip Sint 2000 SAE 10 W/50 Oil Agip F.1 Rotra MP SAE 90 Agip F.1 ATF Dexron
Gear box	0,600 l (20 oz.)	
Converter circuit	1,5 - 1,7 l (approx. 1 1/2 - 1 3/4 qts.)	Agip F.1 Rotra MP SAE 90 Molykote Oil type A Agip F.1 ATF Dexron Agip F.1 Brake Fluid - SAE J 1703
Converter circuit (filling quantity after eventual overhauling)		
Rear drive box	{ 0,230 l (8 oz.) { 0,020 l (approx. 3/4 oz.)	
Front fork (each leg)	0,050 l (1 3/4 oz.)	
Braking circuits (front and rear)		

Checking of accelerating ability

To obtain proper results set the engine at maximum revs with throttle fully opened and brakes fully engaged; release then the brake controls quickly.

Do not operate the clutch, during this checking.

Braking ability

11

Stopping distance from 60 m.p.h. (solo, using the three brakes)	177 feet
Stopping distance from 60 m.p.h. (with pillion, using the three brakes)	190 feet

Passing ability (U.S. Standards)

Passing of a 55 feet long truck, travelling at 20 m.p.h.

— Time	5,5 seconds
— Distance travelled	339 feet

Passing of a 55 feet long truck, travelling at 50 m.p.h.

— Time	6,8 seconds
— Distance travelled	673 feet

The above includes a safety distance of 40 and 100 feet respectively between the passing and pace vehicle at the beginning and end of the maneuver.

12 CONTROLS AND ACCESSORIES

(fig. 2)

- | | | | |
|----|--|----|---|
| 1 | Reservoir (master cylinder), right front brake | 13 | Speedometer (U.S.) Km-Counter (Europe) |
| 2 | Control lever, right front brake | 14 | Front safety bar |
| 3 | Throttle control grip | 15 | Clutch control lever |
| 4 | Starter and engine emergency stop | 16 | Control button, horn - flashing light - turn signal flasher |
| 5 | Control pedal, front left and rear brakes | 17 | Lighting switch |
| 6 | Light and ignition switch | 18 | Starter control lever |
| 7 | Fuel filler cap | 19 | Gear control pedal |
| 8 | Footboard, rider | 20 | Side stand and parking brake control |
| 9 | Reservoir (master cylinder) front left and rear brakes | 21 | Converter, reservoir |
| 10 | Rear safety bar | 22 | Tail and stop lights |
| 11 | Headlight | 23 | Number plate light |
| 12 | Instrument panel with warning lights | | |

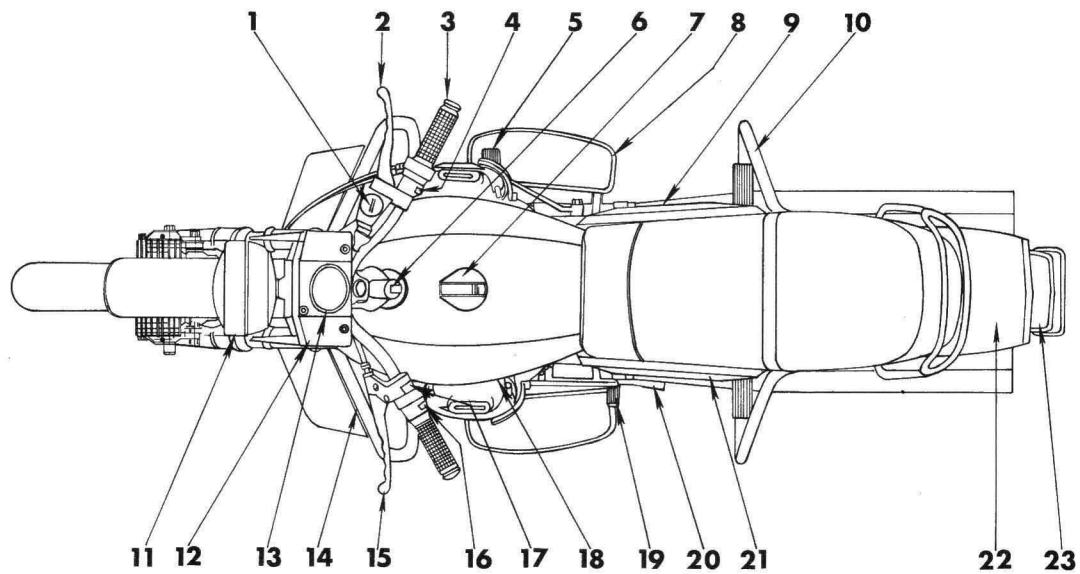

14 IDENTIFICATION DATA

(fig. 3)

Every motorcycle is identified by an identification plate on the frame downtube and one serial number stamped on the engine crankcase.

The identification plate number is also mentioned in the motorcycle log-book and identifies the motorcycle to all legal effects.

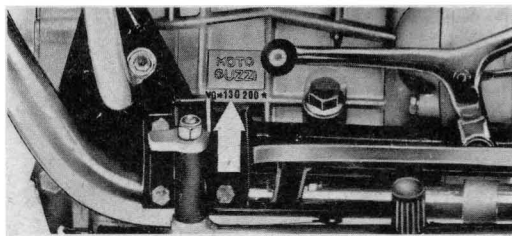
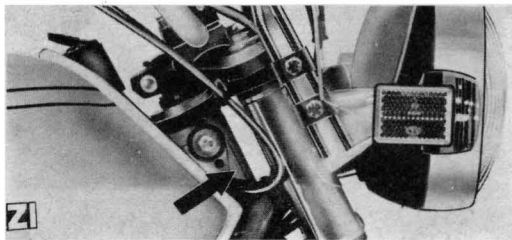

SPARE PARTS

In case of part replacements, ensure that «**Original Moto Guzzi Spare Parts**» only are used. **The use of non-genuine parts invalidates every warranty right.**

WARRANTY

The warranty is valid for a period of 6 months with a limitation to 10000 km from the selling date and expires in case of modifications to the motorcycle or participation to racing competitions.

Tyres as well as parts or accessories which are not manufactured in the «**Seimm - Moto Guzzi Factories**» are out of warranty.

Each new motorcycle is supplied with a «coupon-book». It has to be carefully kept with all other circulation papers as this is the only document entitling the owner of the motorcycle to be recognized of the warranty right from «**Seimm Moto Guzzi**» according the general sale conditions.

INSTRUMENTS AND CONTROLS

(fig. 4)

- 1 Speedometer, Km or Mile counter.
- 2 Warning light (green), left turn signal.
- 3 Warning light (green), right turn signal.
- 4 Warning light (red - U.S.), high beam.
(blue - Europe), high beam.
- 5 Warning light (orange) signalling the disengagement of transmission power and supply of engine starting relay.

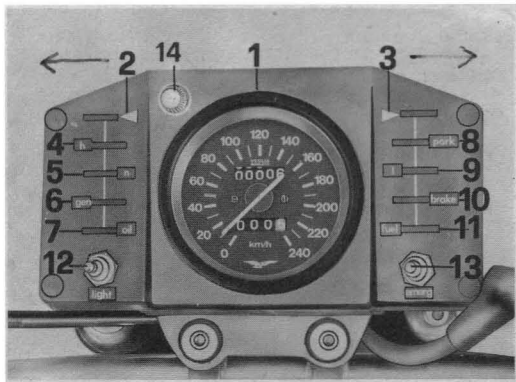

6 Warning light (red) indicating current delivery from generator. It must go out when the engine reaches a certain number of revs.

7 Warning light (red) oil pressure gauge. It goes out when oil pressure is sufficient for normal engine lubrication. Should it not go out, this means that oil pressure is not correct. In this case the engine has to be stopped and suitable checkings are to be carried out.

8 Warning light (green) indicating parking brake engaged. This warning light flashes by turning

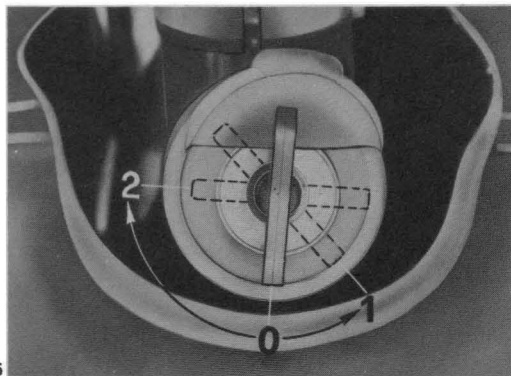

16 the ignition key in position «2» (see fig. 5). If the side stand is not withdrawn, the engine cannot be started.

9 Warning light (red - U.S.) indicating parking light and low beam on.

Warning light (green - Europe) indicating town driving light or low beam on.

10 Warning light (red) indicating incorrect fluid level in front left and rear brake reservoir. When this warning light is on, top up the fluid level and check that braking circuit has no leakages.

11 Warning light (red), fuel reserve. To use the reserve fuel, bring the tap lever on the right fuel tank in position «R» (fig. 10).

12 Courtesy light switch (available).

13 Switch, right and left rear emergency flashers.

14 Odometer or Km counter reset.

Ignition key (fig. 5)

The key has three positions:

«O» Vertical, standstill - key not removable.

«1» Turned counterclockwise, standstill, button «A» (Lights) in line with «Park» (parking light) - key removable.

«2» Turned clockwise, all controls are in; key not removable. After making sure that the side stand is in rest-position (warning light «Park» out) and power transmission is disengaged (warning light «N» on) start the engine by means of button «Start» (fig. 7).

Lighting switch (lights) (fig. 6)

It is located on the right handlebar and has four positions:

«1» OFF Lights out.

«2» PARK Parking light (town driving).

«3» L Low beam.

«4» H High beam.

Light selection is obtained by turning switch «A» (Lights) in the above positions.

To go from position «2» (Park) to position «1» (Off) it is necessary to shift safety button «5» to the left.

Horn, flashing light and turn signals (fig. 6)

Controls are incorporated in block «B»:

- «6» HORN Horn control switch.
- «7» FLASH Flashing light (headlight) control switch.
- «8» Turn signals control button.
When turned to the right (position 9) operates the right signals.
When turned to the left (position 10) operates the left signals.

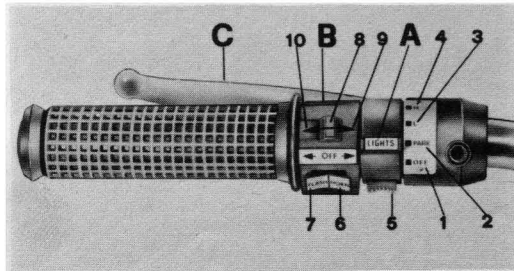

Engine starting and emergency stop button (fig. 7)

17

Right, on the handlebar. With the ignition key in position «2» (fig. 5) the engine is ready to be started.

To start the engine (see «A») press button «1» (Start).

To stop the engine (in case of emergency) turn the lever «2» in position «3» or «4».

After stopping the engine, set the ignition key (fig. 5) in position «0».

Note:

To start the engine, always pull the clutch control lever completely in.

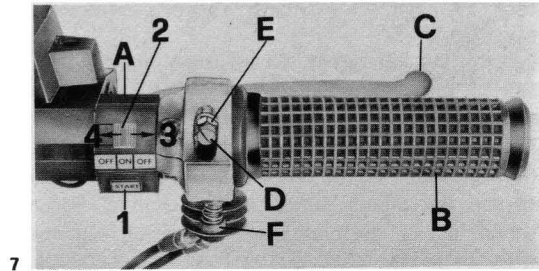

18 Carburettor starter control lever (fig. 29)

The control lever for starting a cold engine is located near the left cylinder head cover.

«B» Starting position.

«C» Riding position.

Throttle control grip («B» in fig. 7)

Right, on the handlebar. Throttle is opened by turning towards the rider and closed viceversa.

Clutch control lever («C» in fig. 6)

Left, on the handlebar. To be used only by starting of the engine and when gearshifting from «Low» to «Drive» or viceversa.

The presence of a hydraulic converter in the transmission system does not exclude absolutely to use the clutch during speed change. For a proper use of the clutch see paragraph «On the way» page 23.

Right front brake control lever («C» in fig. 7)

Right, on the handlebar, connected with fluid reservoir (master cylinder). It operates the right front brake.

Twin brake control, front left and rear brakes (fig. 16)

The control pedal is located on the right side of the motorcycle and is link connected to the fluid reservoir (master cylinder) group.

It operates both front left and rear brakes at the same time.

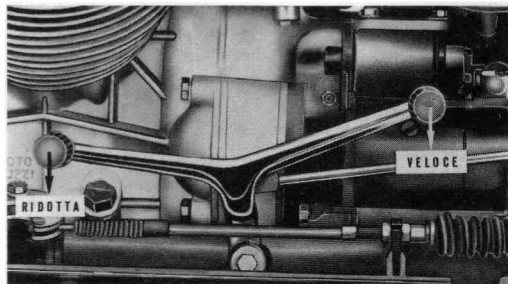

Gear control (fig. 8)

The control lever is located on the left side of the motorcycle and has two positions.

- «1» LOW Front lever towards the ground.
- «2» DRIVE Rear lever towards the ground.

Before actuating the levers pull the clutch control lever completely in.

Fuel filler cap (fig. 9)

To open the cap, press button «A».

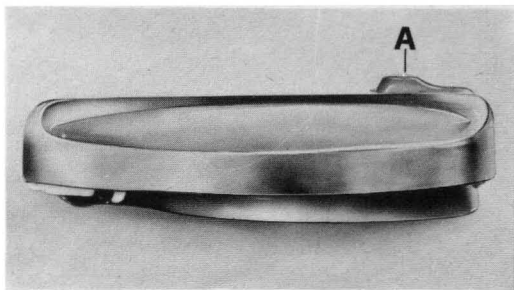

9

Fuel taps (fig. 10)

When there is about 4 l (1 gal.) of fuel in the tank, the cutout «B» actuates warning light «Fuel» on the instrument panel.

To use the reserve fuel (or in case of damage to the automatic fuel feeding electrovalve) act on the fuel tap located on the right side of the fuel tank.

The tap has three positions:

- «A» OPEN Vertical.
- «R» RESERVE Horizontal (see «R» on the tap).
- «C» CLOSED Horizontal (see «C» on the tap).

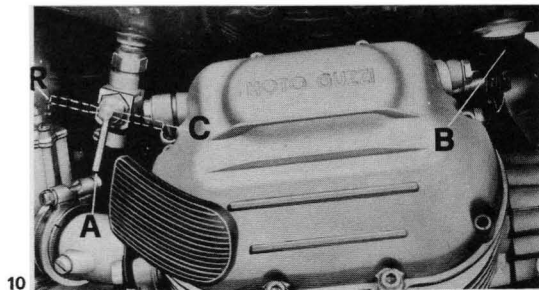

10

20 Electrovalve (fig. 29)

Electrovalve «A» is mounted on the left side of the motorcycle, under the fuel tank and feeds the carburetors.

It works when the ignition key (fig. 5) is in position «2».

Terminal block with fuses (fig. 11)

It is located on the right side of the motorcycle. It is available on removal of right battery cover; n 6 16 A fuses.

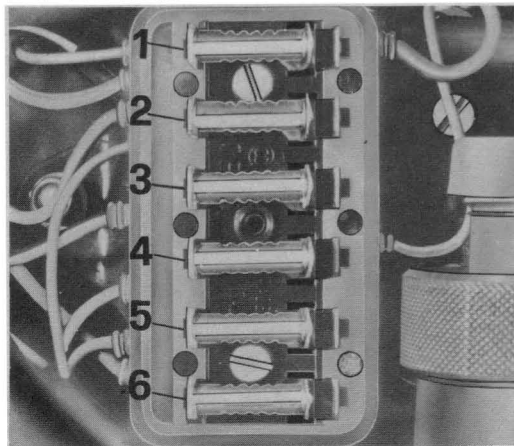

Key controlled

- «1» Rear stop light - Horn - Flash.
- «2» Starter relay - Warning light «N» - Electrovalve.
- «3» Warning lights: Oil - Gen - Brake - Fuel. Headlight: High and Low beam and warning lights.
- «4» Parking lights - Instrument lighting - Warning light «L».

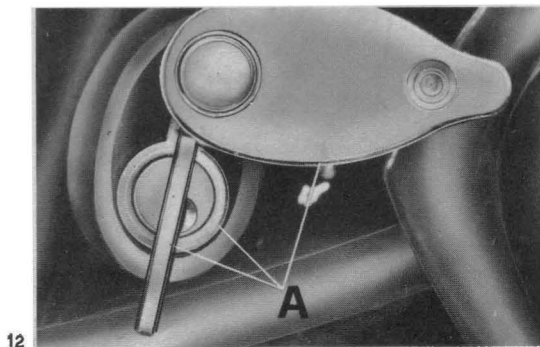

Out of key control

- «5» Additional courtesy light.
- «6» Turn flashers and warning lights.

Steering lock «A» (fig. 12)

To lock or unlock the steering proceed as follows:

Locking:

- turn the handlebar fully to the right;
- insert the key into the lock set, turn it counterclockwise and push it fully in, then release and slip it off.

Unlocking:

- insert the key into the lock set, turn it counterclockwise then release and slip it off.

Motorcycle side stand and parking brake (fig. 17)

This motorcycle is equipped with a rod «A»

which acts as side stand and parking brake control as well.

When it is in parking position (fully out), a special device breaks current delivery to ignition coils.

The warning light «Park» on instrument panel, reminds, by its flashing light, to bring the side stand in rest position to allow the engine to be started.

Checking

- the ignition key is in position «2» (fig. 5).
- Before starting the engine ensure that:
- there is sufficient fuel in the tank (the warning light «Fuel» out).
 - the warning light «Brake» (fluid level in braking circuit reservoirs) is not lit.
 - the oil in the sump is at correct level.
 - the following warning lights are lit: «Oil» (red) «Gen» (red) - by night riding: «1» (red - U.S.) (green - Europe);
 - the «Starter» control lever for cold engine is in starting position «B» (fig. 29).

Starting a cold engine

After the above checking, turn the twist grip 1/4 towards the rider (throttle control) pull the clutch lever fully in, (by this pulling the orange warning light «N» on instrument panel will light indicating

the disengage of power transmission) press the starter button (Start «1» fig. 7).

By keeping the clutch control lever fully pulled in let the engine idle for a short while in the hot season. In the cold season let the engine idle for few minutes with vehicle parked on central stand. Then bring the «Starter» control lever again in riding position «C» (fig. 29).

Should the «Starter» control lever be left in starting position «A» (fig. 29) by riding, there would be irregular carburetion and increased fuel consumption; even worse, there could be the possibility of seizure because of too much petrol going into the cylinders.

Caution

The clutch has to be used only under following conditions:

- starting the engine (as it is not possible to start the engine without disengaging the power transmission);
- gear change (to shift from «Low» into «Drive» or viceversa).

Starting a hot engine

In this case it is not necessary to set the «Starter» control lever in starting position «B» (fig. 29) as this would reachen the carburation too much.

Starting of the engine in case of emergency

In case of damages to the electric starting circuit, the engine can be started only by following conditions and proceeding:

- shift into «Low» speed and pull the clutch control lever completely in;
- get the motorcycle riding at about 60 km/h (37 m.p.h. a.);
- start ~~now~~ the engine by quickly releasing the clutch control lever.

On the way (fig. 8)

Speed is controlled by throttle control twist grip; by turning it towards the rider, speed is gradually

increased (from «O» up to a max. of 130 km/h - 82 mi./h - «Low» and 174 km/h - 108 mi./h - «Drive»); by turning it viceversa speed is decreased.

To change from «Low» speed into «Drive» speed, pull the clutch control lever completely in, give a short acceleration and shift the rear pedal «V» of the gear control towards the ground so that the new speed is quickly and smoothly engaged. Release then the clutch control lever.

To change from «Drive» speed into «Low» speed, act on the throttle control to reduce speed under 130 km/h (82 m.p.h.). Pull the clutch control lever completely in and after giving a short acceleration shift the front pedal «R» of the gear control towards the ground so to quickly and smoothly engage the new speed. Release then the clutch control lever.

Note:

As this motorcycle fits a hydraulic converter, it is not necessary to often use the gear control, lever for quick speed change (which even includes the risk of not disengaging the clutch completely).

The choice of the two speeds has been made by the dual range of riding.

24 «Low» speed: for town or mountain riding (to offer higher acceleration and engine braking ability).

«Drive» speed: for country or high way riding; **in case high acceleration ability is not required it is possible to start and ride in «Drive» speed too.**

Stopping of the motorcycle

Close the throttle control and simultaneously operate both the brake controls.

On wet or slippery roads, the brakes (especially the right front one which is hand controlled) have to be carefully operated.

To stop the engine turn the ignition key to position «O» (fig. 5).

When the engine is stopped (if reserve fuel tap has been used) remember to close the tap by turning the control lever to position «C» (fig. 10).

Parking

By parking at night on insufficiently lighted roads, switch on the parking lights by turning the ignition key to position «1» (fig. 5) and the light

switch «A» (Lights) to position «2» (Park) (fig. 6). To lock steering see proper instructions and fig. 12.

RUNNING IN

During the first 1600 km (1000 miles) a new or overhauled motorcycle has to be used very carefully; as its efficiency, performance and life of the engine are largely dependant on how the motorcycle is run in.

During this period, the engine should never be allowed to reach a high number of revs. before having a chance to warm up sufficiently. Never exceed the following speeds and do not ride the machine at extended high speeds.

Up to 1600 km (1000 miles)

«Low» speed km/h 90 (60 mi./h)

«Drive» speed km/h 120 (75 mi./h)

After the first 500 ÷ 1000 km (300 ÷ 600 miles)

- Check and eventually tighten all nuts and bolts.
- Check and eventually tighten wheel spokes.
- Reset valve rocker clearance.

- Check opening of contact breaker points.
- Replace the engine lubricating oil.

Every 500 km (300 miles)

- Check the oil level in the sump (correct level is nearly at the maximum mark indicated on the filler cap dipstick «A» fig. 23; (fully screw the cap to make this checking).

Let the engine idle for a few minutes before checking oil level.

Note:

For topping up use only oil «Agip Sint 2000 SAE 10W/50». For those markets where this type of oil should not be available, it will be proceeded with the complete replacing by using a type of oil having the same features.

- Check the fluid level in the converter reservoir located on the left side of the motorcycle. Correct level (by a cold engine) is never over the «Max» mark indicated on the filler cap dipstick «A» (fig. 26).

26 MAINTENANCE AND ADJUSTMENTS

Adjusting the clutch control lever (fig. 13)

If the free play at the handlebar is higher or lower than 4 mm (.157") act on adjuster «A» to obtain the correct play.

This adjustment can also be carried out by slackening counternut «C» and acting on adjuster «B» located on the right side of the gear box.

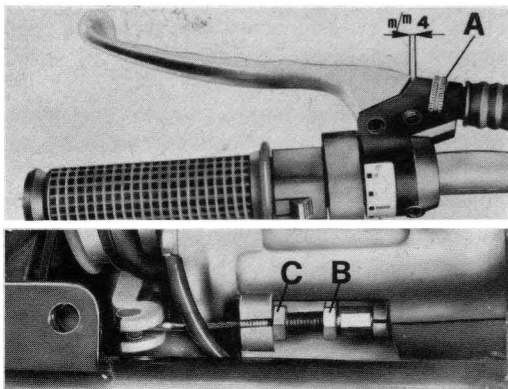

Adjusting the front brake control lever (right) (fig. 14)

Proceed as follows:

- fit a feeler gauge between the floater in master cylinder and the control lever end;
- turn thumb screw «G» to obtain the correct play: mm 0,05 ÷ 0,15 (.0019" ÷ 0059").

Checking the wearing of the brake pads

Every 5000 km (3000 miles a.) check the thickness of the brake pads:

- new pad thick mm 9 (.3543")
- wear limit mm 6 (.2362")

If thickness is below the wear limit, it is necessary to replace the pads.

After this operation has been carried out it is not necessary to bleed the air from from braking

circuits but only operate the control lever on the handlebar «B» (fig. 15) several times until the caliper pistons reach their normal position. When replacing the pads check the conditions of the fluid ducts; should they be damaged replace them immediately.

Checking the braking discs («L» in fig. 14-15)

The braking discs must be clean, without oil, grease or other dirt and must not show any deep groove.

In case of replacement or overhauling of the brake discs, it is necessary to check the fluttering of the same. This checking is carried out by means of a proper gauge that must never read over 0,2 mm (.0079).

Should the fluttering be higher, carefully check the mounting of the discs on the wheel hubs and the play of the hub bearings.

Connection torque between discs and hubs is $2,2 \div 2,4$ kgm.

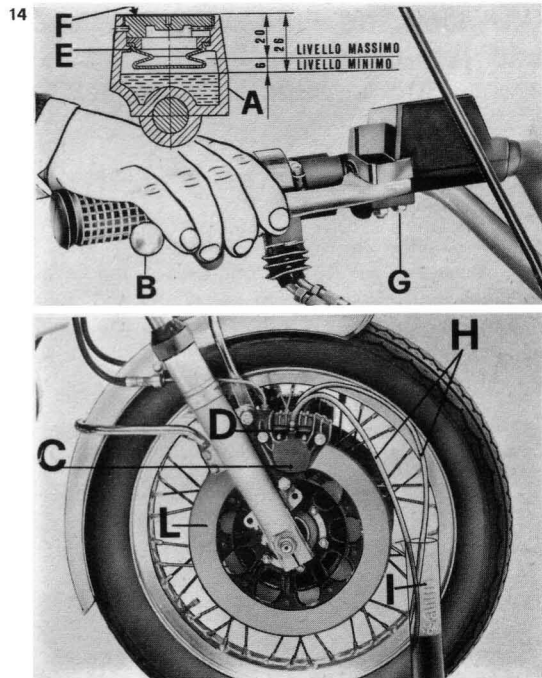

28 Checking the fluid level and replacing the brake fluid in braking circuits (fig. 14-15)

For proper operation of brakes these directions are to be followed:

- periodically check the fluid level.

For reservoir «A» (right front brake) the level must be nearly at the rubber gaiter «E» and must never be lower than 6 mm (.236") under maximum level (see drwg. fig. 15)

15

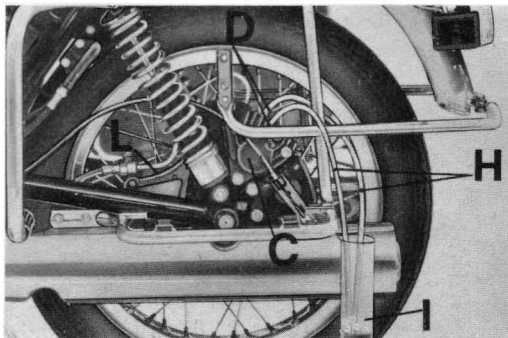
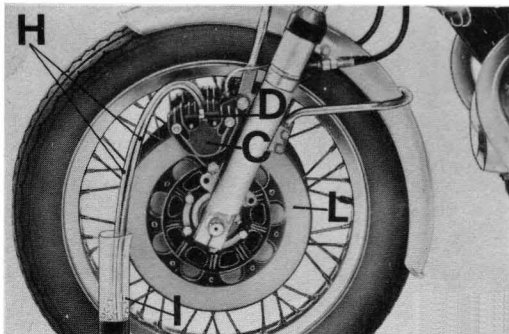
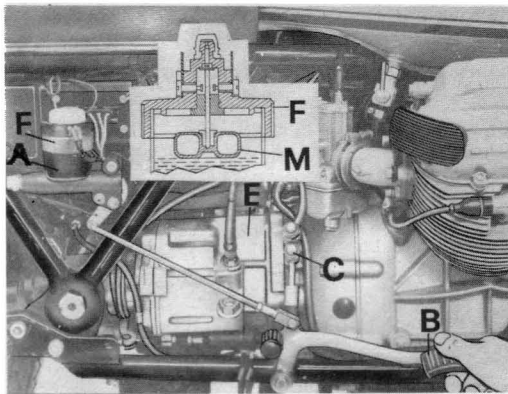

For reservoir «B» (front left and rear brakes) minimum level is indicated by the warning light «Brake» on the instrument panel, actuated by cutout «M» (fig. 16).

For topping up loosen cap «F» of the reservoir (master cylinder) «A» (fig. 16) after disconnecting electric wires .

Take the fluid from original containers which must only be opened when using the fluid.

- completely change the brake fluid every 15000 km (9000 miles) or at least once a year.

The fluid ducts must always be full and without air; a long and elastic movement of the control lever «B» evidences the presence of air inside the ducts.

Use only fresh fluid in case of washing of braking circuits.

No alcohol is to be used for washing and no compressed air for drying; use Trichloroethylene for metallic parts.

Fluid to be used: «Agip F.1 Brake fluid SAE J 1703».

Air bleeding from braking circuits (fig. 14-15)

This operation is required when the movement

of the control lever on the handlebar is long and elastic because of the presence of air inside the braking circuits.

Operations are as follows:

Braking circuit for right front brake (fig. 14)

- turn the handlebar until the fluid reservoir «A» reaches the horizontal position (take care that during the air bleeding the fluid does not go 6 mm (.236") lower than the maximum level);

- act on one caliper half «C» at a time:

- a) take out the rubber cover, then fit a transparent flexible duct «H» on the drain plug «D»; the other end of this duct will be plunged into a transparent container «I» partially filled up with fluid of the same type

- b) loosen the drain plug «D»;

- c) completely operate several times the brake control lever «B» on the handlebar; release it slowly and wait for a few seconds before operating it again. Repeat this operation until the duct plunged into the transparent container emits airless fluid;

d) keep the control lever «B» completely drawn and, lock the drain plug «D» then take off the duct «I» and mount the rubber cover.

If the air bleeding has been correctly carried out, a direct and efficient working of the fluid will be realized immediately after the initial idle movement of the lever «B»; otherwise repeat the air bleeding.

Front left and rear braking circuit (fig. 15)

Operations are the same as by the air bleeding of the right front braking circuit, except points «c» and «d»:

c) completely operate several times the control pedal «B» on the right side of the motorcycle....

d) keep the control pedal «B» completely pushed down.....

Adjusting the front left and rear brake control pedal (fig. 16)

Check clearance between floater and control lever «C» by proceeding as follows:

- fit a feeler gauge between the floater in ma-

ster cylinder and the end of the control lever «G», turn thumb screw «A» to obtain the correct play: $\text{mm } 0,05 \div 0,15$ (.0019" \div .0059").

In case such an adjustment should cause the control pedal position to change, or when such a position has to be changed because of personal requirements, proceed as follows:

- take off the circlip, slip off the pin and loosen counternut «B», screw in or out fork «C» until the control pedal «E» comes to the correct or desired position;

- re-fit the retaining pin and the circlip.

This done, loosen counter nut «E» and adjust screw «D», travel end for lever return.

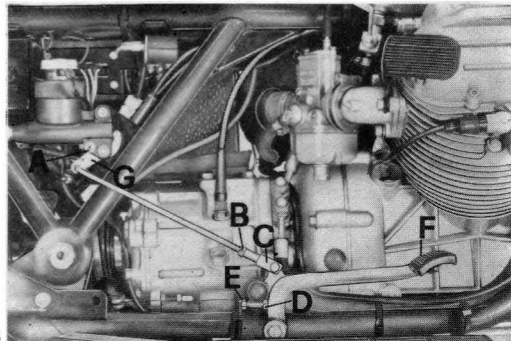

Adjusting the side stand (parking brake control) (fig. 17)

The parking brake is mechanically actuated by side stand «A».

The load to the stand from a parked vehicle is delivered through a transmission system consisting of levers «C» and devices «D» to brake pads «F» in caliper «E». In this way the brake disc «B» is blocked.

In case of insufficient braking power act on adjuster screw «H» after loosening counter nuts «G».

17

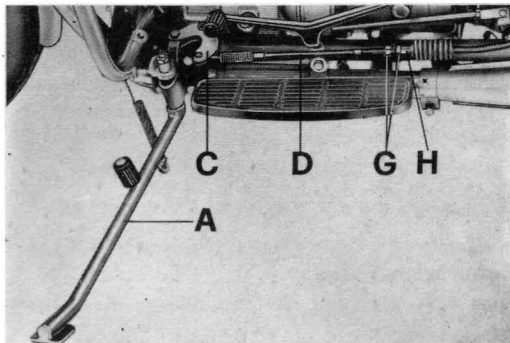

31

Adjusting the rear suspensions (fig. 18)

The external springs of the rear suspensions can be adjusted to three positions by means of proper lever «A».

Should an irregular working of the hydraulic dampers be realized, have them checked by our dealers.

Caution:

Do not forget that the two springs have to be adjusted to the same position to ensure a good stability of the motorcycle.

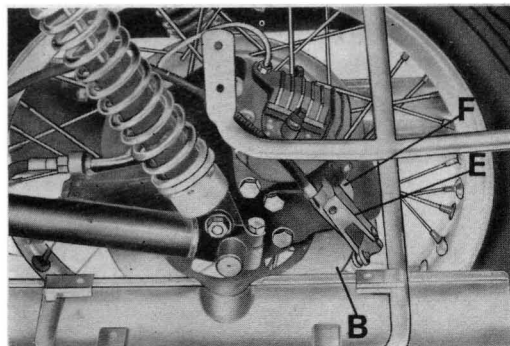

32 Adjusting the steering (fig. 19)

For a safe riding, the steering has to be so adjusted as to allow a free movement of the handlebar but without excessive play.

To correctly adjust it operate as follows;

- slacken the steering head fixing bolt «A»;
- screw in or out the adjuster nut «C» to take up excessive play.

This done, lock nut «B» and steering head fixing bolt «A».

It is recommended to have this operation carried out by our dealers.

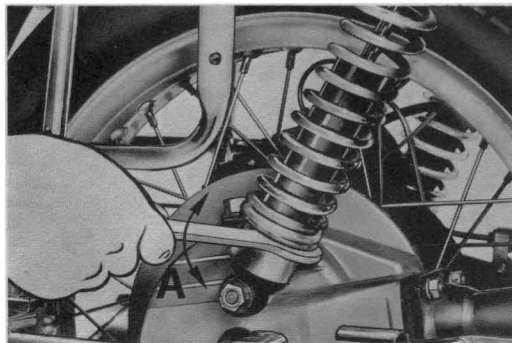

18

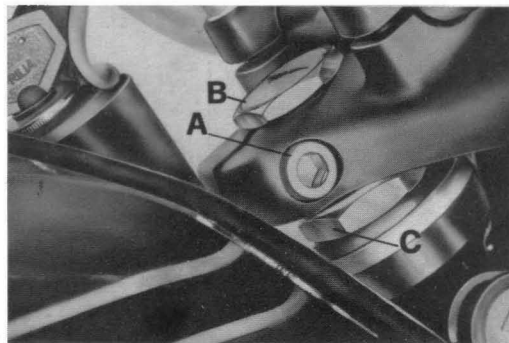

19

REMOVAL OF WHEELS

Front wheel (fig. 20)

To remove the front wheel proceed as follows:

- undo screws «F» and «G» securing caliper «A» to the left fork cover; now take caliper out of brake disc by lifting it slightly;
- undo spindle retaining nut «B», on the right side;
- undo screws «C» fixing fork covers to spindle;
- slip off spindle «D»;
- lift the motorcycle so to allow the brake disc to be taken out of the caliper still mounted on the right fork cover.

By re-fitting operate viceversa paying attention to the position of spacer «E» (on the right side).

Rear wheel (fig. 21)

To remove the rear wheel proceed as follows:

- undo the screw securing left silencer to frame and slip off the silencer from its exhaust pipe after loosening the clamp fixing screw;

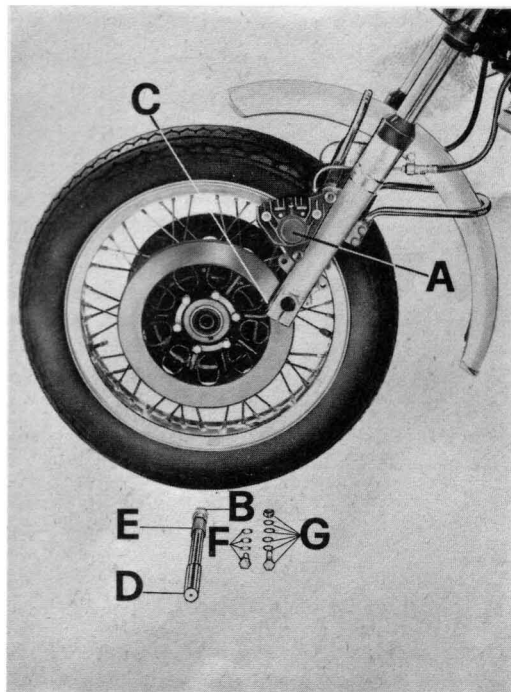

- undo nut «B» on spindle, drive box side;
 - undo the screw securing the spindle «C» to the rear fork arm;
 - take spindle «D» out of drive box, wheel hub and rear fork arm;
 - take braking disc out of caliper «E»;
 - after disconnecting the brake control cable, slip off the plate complete with hydraulic and mechanical calipers. Do not disconnect the hydraulic duct;
 - lean the vehicle on the right side so allow the wheel «F» to be slipped off from rear fork arm and drive box.
- By re-fitting operate viceversa, paying attention to fit the plate complete with calipers on the rear fork and to connect the parking brake control cable to its lever.

Adjusting the spokes

Check that all spokes are tightened and the wheel is trued by proceeding as follows:

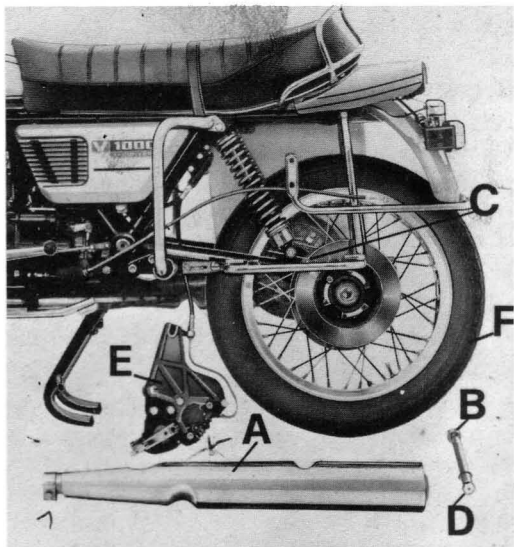

- turn the wheel and check its truing. If necessary adjust right or left spokes until the wheel turns properly. This checking has to be done after the first 500 km (300 miles a.) and later at every 1500 km (900 miles a.).

Wheel balance

To improve stability and decrease vibrations at high speeds, the wheels have to be kept balanced.

Operations are as follows:

- ensure that all spokes are tightened and the wheel is trued;
- remove the wheel and suspend it on a fork;
- lightly spin the wheel several times and see if it always stops in various positions, thus indicating a correct balance;
- if one point of the wheel always stops at the bottom, put a balance weight on the spoke opposite this point;
- repeat this operation until the wheel is correctly balanced, then fix the balance weights to the spokes by means of pliers.

Balance weights are available by our dealers.

Tyres

Tyres are included in the components which must be very carefully checked: as vehicle sta-

bility, riding comfort and even rider safety are dependant on them. Therefore it is not advisable to use tyres having less than 2 mm ($1/16''$) thickness tread.

An incorrect tyre pressure may affect the vehicle stability and cause the tyre to quickly wear out.

Recommended pressures are:

- front wheel:

solo or with pillion	kg/sqcm 2,1 (31 p.s.i.)
----------------------	-------------------------
- rear wheel:

solo	kg/sqcm 2,4 (32 p.s.i.)
with pillion	kg/sqcm 2,6 (38 p.s.i.)

The above figures are suggested for normal riding (cruising speed).

If using the motorcycle at constant high speed, or on high ways, it is recommended to increase pressure by 0,2 kg/sqcm (3 p.s.i.).

36 LUBRICATION AND MAINTENANCE CHART

(fig. 22)

Monthly (or every 3000 km
2000 miles a.)

1 Check the electrolyte level in the battery (see **Electrical equipment** «Battery»).

Periodically

2 Check tyre pressure (see **Removal of wheels** «Tyres»).

Every 500 km (300 miles a.)

3 Check the oil level in the engine crankcase (see **Engine lubrication**).

4 Check the oil level in the converter reservoir (see **Converter lubrication**).

After the first 500-1000 km
(300-600 miles a.)

5 Replace the oil in the engine crankcase (see **Engine lubrication**).

6 Check that all nuts and bolts are tightened.

7 Check that all wheel spokes are tightened and the wheels are trued (see **Removal of wheels** «Adjustment of spokes»).

8 Check rocker clearance (see **Valve gearing**).

Every 1500 km (900 miles a.)

9 Check that all wheel spokes are tightened and the wheels are trued (see **Removal of Wheels** «Adjustment of spokes»).

Every 3000 km (2000 miles a.)

10 Replace the oil in the engine crankcase (see **Engine lubrication**).

11 Check rocker clearance (see **Valve gearing**).

12 Check the oil level in the gear box (see **Gear box lubrication**).

13 Check the oil level in the rear drive box (see **Rear drive box lubrication**).

Every 5000-6000 km (3000-4000 miles a.)

14 Check the fluid level in the fluid reservoir (master cylinder) for right front brake. An incorrect fluid level in the reservoir for left front brake and rear brake is indicated by a proper warning light (red) on the instrument panel (see **Maintenance and adjustments** «Checking and replacing the brake fluid»).

Every 10000 km (6000 miles a.)

15 Clean the fuel tank, fuel filters and pipes (see **Carburetion** «Cleaning fuel tank, fuel taps, fuel filters and pipes»).

16 Replace the oil in the gear box (see **Gear box lubrication**).

17 Replace the oil in the rear drive box (see **Rear drive box lubrication**).

18

19 Clean and smear all battery connection (see **Electrical equipment** «Battery»).

20 Replace the air filter (see **Carburetion** «Air filter»).

Every 15000 km (9000 miles a.)

21 Replace the fluid in the braking circuits (see **Maintenance and adjustments** «Checking and replacing the fluid in braking circuits»).

22 Replace oil filter cartridge (see **Lubrications** «Replacing the oil filter cartridge and cleaning the wire gauze filter»).

After the first 20000 km (12000 miles a.)

All checkings hereunder described must be carried out by our dealers:

23 Check the condition of the wheel bearings.

24 Check that the steering bearings are sufficiently greased «Agip F.1 Grease 30».

25 Replace the oil in the fork legs (see **Fork lubrication**).

26 Clean starter motor and generator commutators using a clean rag slightly moistened with petrol.

EVERY 500 KM (300 MILES): _____

AFTER THE FIRST 500-1000 KM (300 ÷ 600 MILES): _____

EVERY 1500 KM (900 MILES): _____

EVERY 3000 KM (2000 MILES): _____

EVERY 5000/6000 KM (3000/4000 MILES): _____

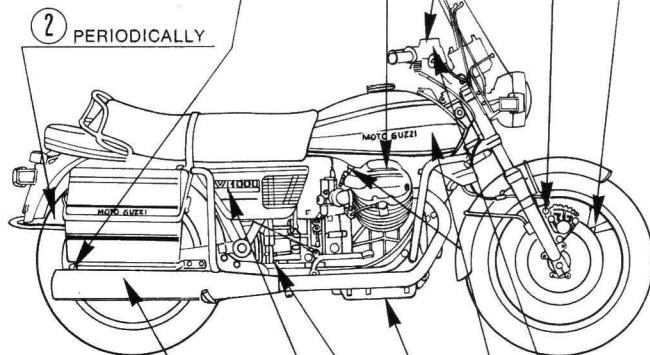

EVERY 10000 KM (6000 MILES): _____

EVERY 15000 KM (9000 MILES): _____

EVERY 20000 KM (12000 MILES): _____

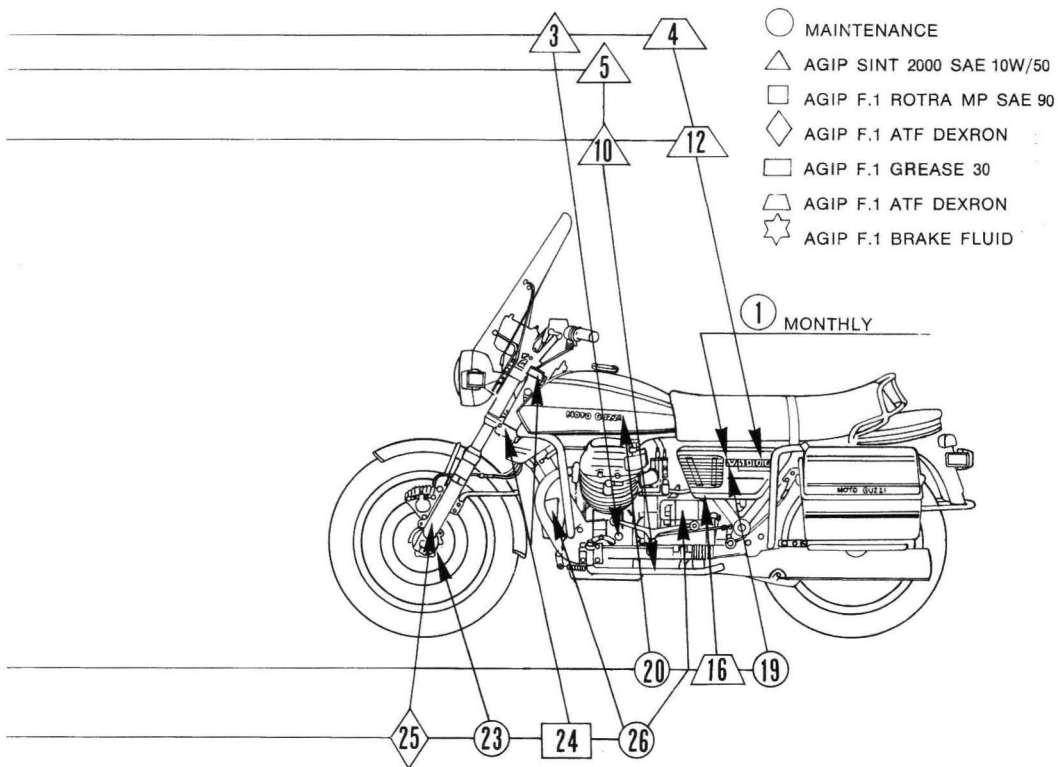

40 LUBRICATIONS

Engine lubrication (fig. 23)

Checking the oil level

Every 500 km (300 miles a.) check the oil level in the engine crankcase.

Correct level is nearly at the maximum mark on the filler cap dipstick «A». If level is not correct, top up with oil of same quantity and feature.

Let the engine idle for a few minutes before checking the oil level: the filler cap dipstick «A» must be fully screwed.

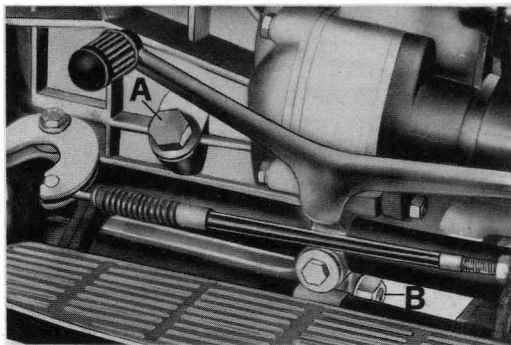

23

Replacing the engine oil

After the first 500 ÷ 1000 km (300 ÷ 600 miles a.) and later on every 3000 km (2000 miles a.) or so replace the engine oil. The replacement is to be made by a warm engine. Allow the old oil to drain before adding fresh oil.

«A» Filler cap dipstick.

«B» Oil drain plug.

Quantity required: 1.3 of oil «Agip Sint 2000 SAE 10W/50» (approx. 3 qts.).

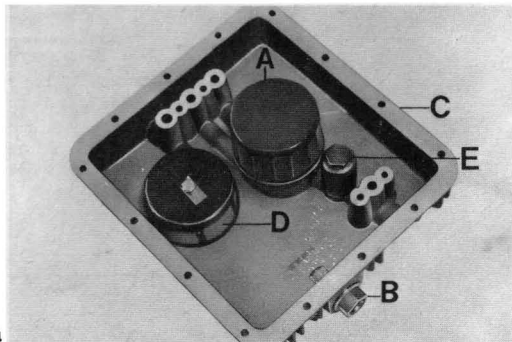

24

Replacing the oil filter cartridge and cleaning the wire gauze filter (fig. 24)

Every 15000 km (9000 miles a.) (5 oil replacements) replace the filter cartridge «A» by proceeding as follows:

- undo plug «B» and let the oil fully drain;
- undo fixing screws and remove the oil sump; the filter cartridge «A», and the wire gauze filter «D» are mounted inside the sump;
- undo the filter cartridge «A» and replace it by an original one.

When replacing the filter cartridge «A», it is recommended to remove the wire gauze filter «D» too. Wash it in petrol bath and dry it by means of a compressed air jet. Before mounting it blow the sump with compressed air.

Replace the gasket too, before fixing the sump to the engine crankcase.

This service is best performed by our dealers.

Lubrication of the gear box (fig. 25)

Checking the oil level

Every 3000 km (2000 miles a.) check that the oil level is nearly at the hole of the filler cap «A». If level is lower, top up with oil of the same quality and features.

Replacing the oil

Every 10000 km (6000 miles a.) replace the oil in the gear box.

This replacement will be done after warming up as in this condition the oil is fluid and easy to drain.

«A» Filler and level checking cap.

«B» Oil drain plug.

Quantity required: l. 0,600 (20 oz.) «Agip F.1 Rotra MP SAE 90».

42 Lubrication of converter (fig. 26)

Checking the oil level

After the first 500 km (300 miles a.) and later on every 3000 km (2000 miles a.) check the oil level in the converter reservoir. Such a level must not be higher than the (Max.) mark and lower than the (Min.) mark indicated on the cap «A» dipstick. For topping up use only the recommended type of oil. Take care that the necessary quantity to bring level from (Min.) to (Max.) is about 1 0,250 (8 oz.).

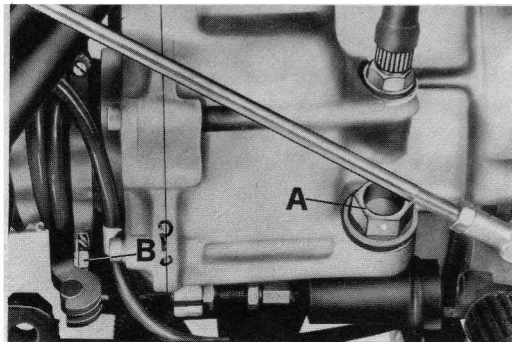

25

The cap «A» must be fully screwed, by this checking.

Recommended oil: «Agip F.1 ATF Dexron».

Replacing the oil in the hydraulic converter circuit

Every 30000 km (20000 mi.) or so it is necessary to replace the oil in the hydraulic converter circuit by proceeding as follows:

- undo the filler cap «A» on the reservoir;
- undo the drain filter «B» from the reservoir;
- undo the connection «C» (fig. 15) on the converter gear box.

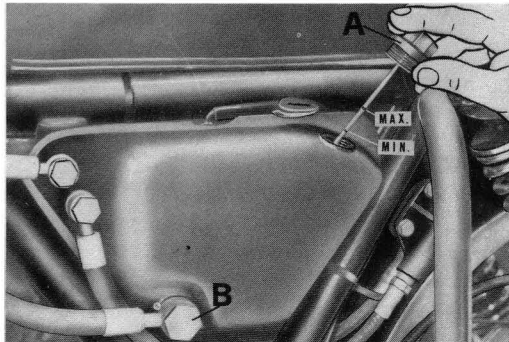

26

After draining the oil from reservoir and radiator, wash the filter «B» with petrol and blow it with compressed air; re-fitting takes place viceversa. Anyway it is to be considered that the oil will never be fully drained.

Fill up the reservoir with oil according to the following instructions.

Filling up the converter hydraulic circuit (after eventual overhauling)

In case the hydraulic circuit has been overhauled, that's when the converter, pipes and oil reservoir have been oil drained, the filling up and checking of the oil level in the reservoir will have to be done as follows:

- fill up the reservoir until the (Max.) mark, with the motorcycle staying on its stand in plane position;
- start the engine and let it idle for a few minutes checking that there is always oil in the reservoir, if necessary add oil;
- stop the engine and check the oil level as indicated in «**Converter lubrication - Checking the oil level**».

This service is best carried on by our dealers.

Lubrication of the rear drive box 43 (fig. 27)

Checking the oil level

Every 3000 km (2000 miles a.) check that the oil level is nearly at the hole of the cap «A»; if level is not correct top up with oil of same quality and features (see following instructions).

Replacing the oil

Every 10000 km (6000 miles a.) replace the oil in the rear drive box.

This replacing has to be done with a warm engine as oil is easier to be drained. Let the oil fully drain before adding fresh oil.

«A» Level checking cap.

«B» Filler cap.

«C» Oil drain plug.

Quantity required: l 0,250 of which:

l 0,230 (approx. 3/4 pint) oil «Agip F.1 Rotra MP SAE 90».

l 0,020 (approx. 3/4 oz.) oil «Molykote type «A».

44 Front fork lubrication (fig. 28)

To replace the oil in the fork legs proceed as follows:

- undo the drain plug with gasket «A»;
- undo screw «B».

Before introducing fresh oil, let the fork legs fully drain.

«A» Oil drain screw.

«B» Oil filler screw.

Quantity required: 1 0,050 (approx. $\frac{13}{4}$ oz.) (half a glass about) for each leg «Agip F.1 ATF Dexron».

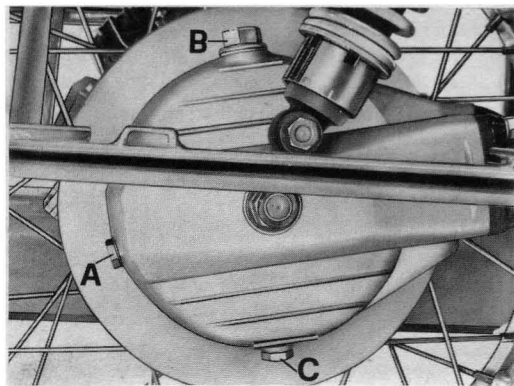

27

Lubrication of the steering and rear fork bearings

It is recommended to apply to our dealers for this service.

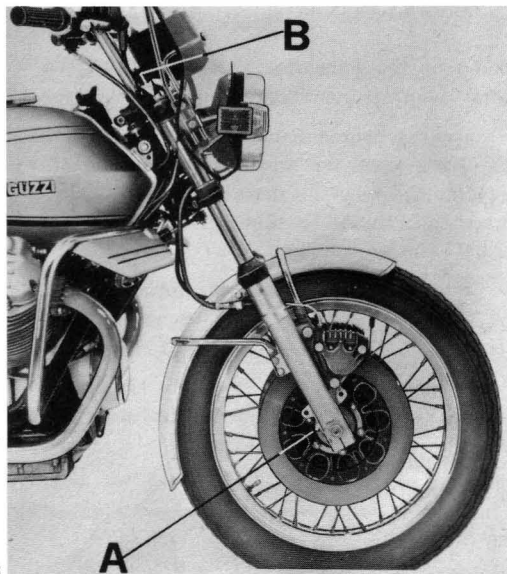

28

CARBURETION

Carburetors (fig. 29)

N. 2 type Dell'Orto VHB 30 CD (right) VHB 30 CS (left).

Controls:

- throttle control grip («B» fig. 7) on the right handlebar;
- starter lever, for starting a cold engine, on the left cylinder head cover.

«B» Starting position.

«C» Riding position.

Note:

With the starter lever in position «C» (riding) check that there is a clearance of 3 mm (.11") between cable ends and adjuster screws «H» of both carburetors.

Standard carburettor setting

Throttle	∅ mm 30
Choke	40

Atomizer	265
Main jet	130
Idling jet	50
Starter jet	80
Needle	V 9 (2nd notch)
Floater	10 grams

Idling screw: opening 1 turn and a half.

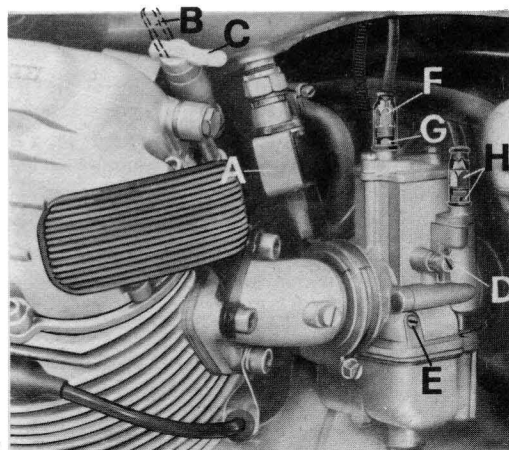

46 Adjusting the carburetion and idling speed (hand adjustment)

(fig. 29)

Proceed as follows

1 Warm the engine to its normal running temperature.

2 Fully screw in screws «E» idling adjusters, then undo them by 1 turn and a half.

3 Check with your hands if the exhaust pipe pressures are equal. If necessary act on screws «D» of a carburettor until the pressure will be the same (idling speed will have to be kept at 900-1000 r.p.m. about; as a consequence it will be necessary to screw in the screw of the carburettor for the cylinder giving a lower exhaust pressure, or screw out the screw of the carburettor for the cylinder giving a higher exhaust pressure).

4 Acting on screws «E» get the best carburation for each cylinder (it is realized by an increase of r.p.m.) and adjust then idling speed according point 3.

5 Disconnect one spark plug lead at a time and check that the engine in both cases stops after firing 5-6 strokes. If this does not occur, screw out screw «D» of carburettor making the engine firing more than 5-6 strokes, or — if this is the case — screw in screw «D» of carburettor making the engine firing less than 5-6 strokes.

6 Adjust idling speed at 900-1000 r.p.m. by screwing or unscrewing both screws «D» by the same amount.

7 With throttle control grip closed check that there is a clearance of mm $1 \div 1,5$ (.039" \div .059") between cable ends and wire adjuster screws «F» of both carburettors.

8 Ensure that throttles open simultaneously by proceeding as follows: gradually turn the throttle control grip and check that exhaust pipe pressure increases in synchronization by means of both hands. (An assistant will be needed for this operation). If pressure increase of one cylinder is advanced, act on its carburettor by gradually screwing in wire adjuster «F», after loosening counternut «G», until the synchronization of both exhaust pipes pressure is reached.

Adjusting the carburetion by means of a vacuum gauge

To obtain a proper adjustment of carburetion, it is necessary to apply to our dealers who can carry out this operation by means of a «Vacuum Gauge».

Air filter cartridge (fig. 30)

Every 10000 km (6000) miles a.) replace the air filter cartridge «A».

This filter is located in its proper box together with the oil breather under the fuel tank.

For this replacement it is recommended to apply to our dealers.

Cleaning the fuel tank, fuel taps, fuel filters and pipes

Every 10000 km (6000 miles a.) or in case of irregular fuel flow to carburetors, it is necessary

to clean the fuel tank, the fuel taps, the filters on carburetors and the fuel pipes.

Such parts will be cleaned by means of petrol and dried by means of compressed air.

47

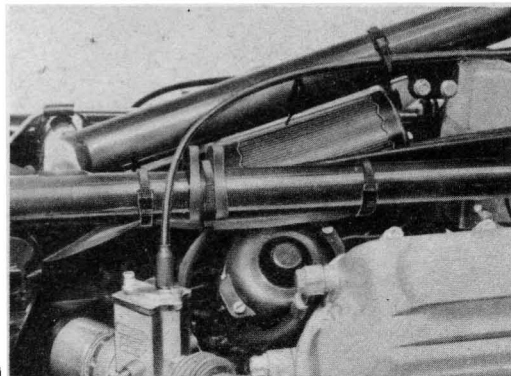

30

48 VALVE GEARING

Tappet clearance (fig. 31)

After the first 500 ÷ 1000 km (300 ÷ 600 miles a.) and later on every 3000 km (2000 miles a.) or any time valve operation is too noisy, tappet clearance should be checked.

This adjustment is made by a cold engine with the piston at TDC exactly at the end of its compression stroke (valves fully closed).

After removing the head cover, operate as follows:

1 Slacken nut «A».

2 Screw in or out the adjuster screw «B» until the following clearances are obtained;

- inlet and exhaust valve: mm 0,22 (.0086").

Use a feeler gauge «C» to check clearance.

In case of higher clearance, there will be noisy valve operation; while in case of lower clearance the valves do not close fully causing inconveniences such as:

- compression loss;
- engine overheating;
- valve burning.

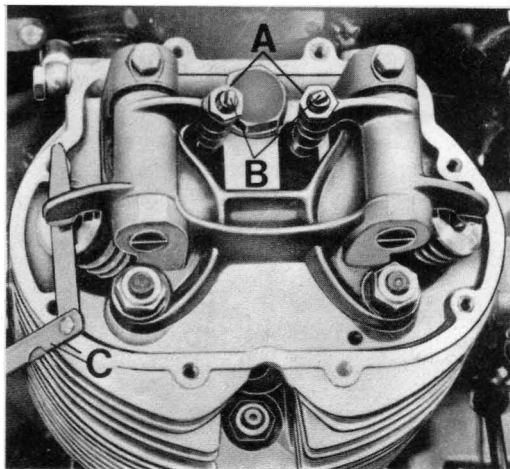

IGNITION

Checking and adjustment of double contact breaker (fig. 32)

Maintenance

Every 3000 km (2000 miles a.).

Lightly moisten with some engine oil drops the felt «R» located on the cam plate.

Inspection

- remove the contact breaker cover after undoing securing screws;
- if contacts «A» and «B» are dirty and greasy, clean them with a petrol moistened rag. If they are in any way damaged, replace them;
- check points gap of breaker «A» (right cylinder - red cable) and breaker «B» (left cylinder - green cable) which should be between mm 0,37 ÷ 0,43 (.014" ÷ .016").

Adjustment of contact points

Contact points «A» - right cylinder

Bring cam to the maximum lift, loosen screws

«C» and «D» and move plate «E» by acting on notch «F».

After setting the correct distance, lock screws «C» and «D».

Contact points «B» - left cylinder

Bring cam to the maximum lift, loosen screws «G» and «H» and move plate «L» by acting on notch «M».

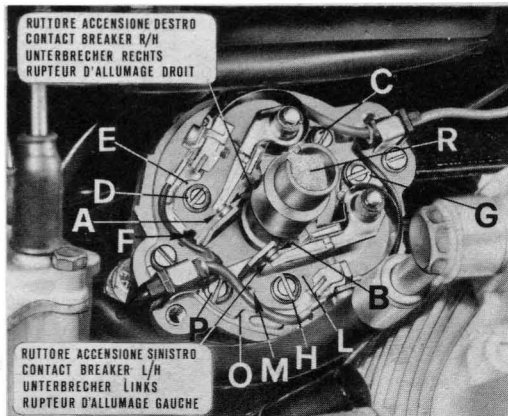

After setting the correct distance, lock screws «G» and «H».

When adjusting the contact points, ignition timing should be checked as well (see following chapter).

Checking and adjustment of ignition timing «fixed advance»

(fig. 33)

Inspection

- remove the rubber cap which seals the inspection hole on the converter box in correspondence with engine flywheel;
- to find the exact moment when the points «A» and «B» (fig. 32) start separating, it is advisable to use a suitable timing light device to be fitted between the breaker feeding clamp and the ground.

Timing the right cylinder

- rotate the flywheel in the engine rotation sense (counterclockwise) until the piston is at the end of its compression stroke (both valves closed). At this point mark «D» on the flywheel

(TDC of right cylinder) should coincide with mark «1» on the inspection hole rim;

- rotate the flywheel clockwise until the mark «2» on the flywheel (fixed advance) is in perfect coincidence with mark «1» on the inspection hole rim. At this point contact points of breaker «A» (fig. 32) start opening.

33

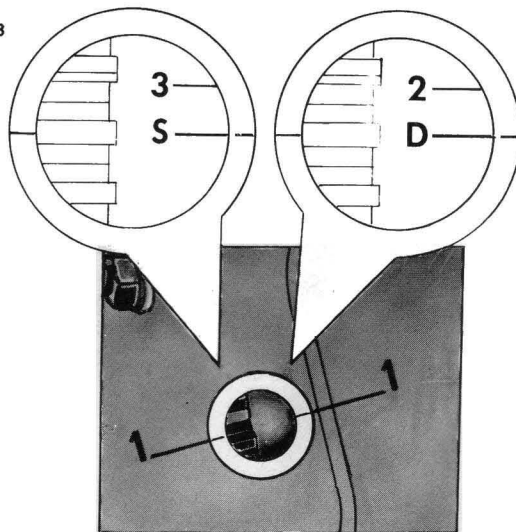

Timing the left cylinder

- rotate the flywheel in the engine rotation sense (counterclockwise) until the piston is at the end of its compression stroke (both valves closed). At this point mark «S» on the flywheel (TDC of left cylinder) should coincide with mark «1» on the inspection hole rim;
 - rotate the flywheel clockwise until the mark «3» on the flywheel (fixed advance) is in perfect coincidence with mark «1» on the inspection hole rim. At this point contact points of breaker «B» (fig. 32) start opening. ffi
- If the contact points of breakers «A» and «B» (fig. 32) do not start opening in the above positions, the ignition timing need adjustment.

Ignition advance data

— initial advance (fixed)	2°
— automatic advance	31°
— full advance (f. + a.)	33°
— breaker contact points gap	mm 0,37 ÷ 0,43 (.014" ÷ .016")

For this service, it is recommended to apply to our dealers.

Spark plugs

The type of spark plugs to be used is indicated at page 6.

Spark plug points gap: mm 0,6 (.023").

The spark plugs are best cleaned with petrol and a wire brush, using a needle for the inner part. In re-fitting the spark plugs ensure they are properly started by hand for a few turns completing the operation by means of the proper wrench in the tool kit. If not properly started, the cylinder head thread may get stripped.

For all events, the plugs have to be replaced every 10000 km (6000 miles a.) even if they appear to be still in good conditions.

52 ELECTRICAL EQUIPMENT

The electrical equipment consists of:

- Battery.
- Starter motor with electro magnetic ratchet control.
- Generator/alternator, located on the front side of crankshaft.
- Double contact breaker with automatic advance.
- Ignition coils.
- Rectifier.
- Regulator.
- Terminal block with fuses (n. 6, «16 A» fuses).
- Flasher relay.
- Starter relay.
- Headlight.
- Tail light.
- Turn indicator lights.
- Ignition switch.
- Light switch.
- Turn indicators, horn and flashing light control switch.
- Engine starting and stopping button.
- Electric horns.

Battery

Battery is a 12 V type with a capacity of 32 Ah; direct charge from generator.

Access to the battery is made possible by following operations:

- lift the saddle by means of lifting lever;
- remove the tool box;
- unhook the rubber bands and disconnect electric wires.

Putting a new battery into service

1 Unscrew the plugs and introduce pure sulphuric acid for batteries with a specific gravity 1,28 kg/l (1,23 kg/l in tropical climates) and temperature +20°C until the minimum level mark on the battery is reached. At introduction, acid temperature must not be lower than +10°C. Do not use metal funnels.

2 Let the battery at rest for about one hour, then top up to the recommended level by adding sulphuric acid. Charge now the battery for 15 hours in c.c. - Amp. 1,1. Start charging only when temperature is lower than +40°C (+50°C in tropical climates).

To charge battery connect positive pole (+) of battery to positive pole (+) of supplier; same connection for negative poles (—).

During charging, the temperature of sulphuric acid must not be higher than +45°C (+55°C in tropical climates); otherwise stop charging or reduce current.

The initial charge will be accomplished when acid density and current intensity rates will re-

main the same for at least two consecutive hours of charging.

At this point specific gravity of acid will have to be 1,28 kg/l \pm 0,01 (1,23 kg/l \pm 0,01 in tropical climates) at +20°C.

It is to be considered that the specific gravity of acid varies 0,01 for each temperature change of 14°C; this means that the specific gravity of an acid at +34°C will have to be increased of 0,01 to obtain the specific gravity at +20°C.

Two hours after the charge end check the acid level, if necessary top up with distilled water, then screw in the filling caps. The battery is now ready to be in service.

Maintenance

Check periodically the electrolyte level, add only distilled water whenever necessary. Check that all battery connections are well tight and clean, smear them with neuter vaseline.

Replacing of bulbs

Headlight (fig. 34)

Undo screw «B» to disconnect the headlight in-

54 sert, remove of the two bulb sockets, then replace the bulbs.

Tail light (fig. 35)

Undo screws «D» securing reflector to tail light, push the bulb inwards and turn it at the same time, then slip it off.

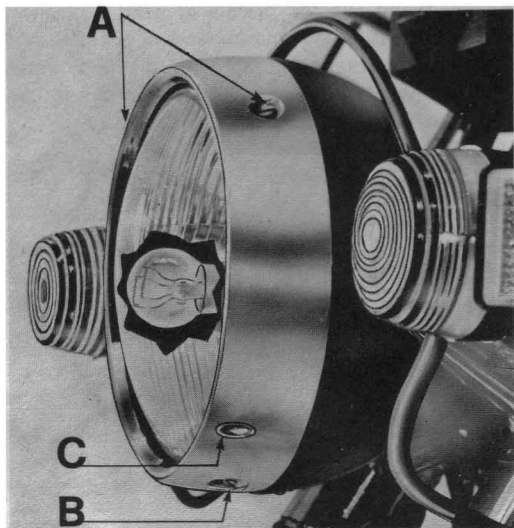

EUROPE MODEL

Turn indicator lights (fig. 35)

Undo screw «E» securing reflector to turn indicator lights, push the bulbs inwards and turn them at the same time, then slip them off.

By re-fitting of reflectors, screw in carefully the fixing screws not to break the reflectors.

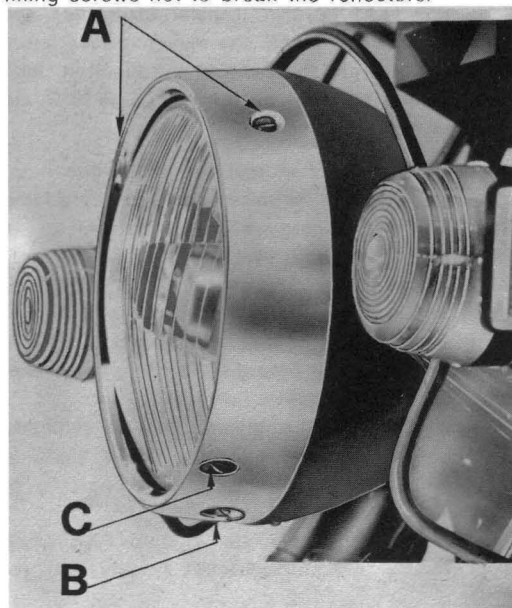

U.S.A. MODEL

Number plate light (fig. 35)

Undo screws «F» securing the light glass, push the bulb inwards and turn it at the same time, then slip it off.

Instrument panel, Speedometer, Rev. Counter

Take bulb sockets out of instrument panel, speedometer and rev. counter, then replace the bulbs.

Bulbs

Headlight (Europe model):

- high and low beam 45/40 W
- town driving light 3 W

Headlight (U.S.A. model):

- sealed beam insert 45/40 W

Tail light:

- parking and stop light 5/21 W
- number plate light 5 W
- Turn indicator lights 21 W
- Warning lights 1,2 W
- Speedometer and rev. counter lights 3 W

Adjusting the headlight beam (fig. 34)

55

The headlight must always be adjusted at the right height, either for a safe riding or not to trouble crossing riders. For the horizontal adjusting act on screw «A», for vertical adjusting act on screw «C» until the correct height is reached. The high beam centre must not be higher than 0,86 m (approx .34") measured at 3 m (approx 10") distance with motorcycle not on stand rider on saddle.

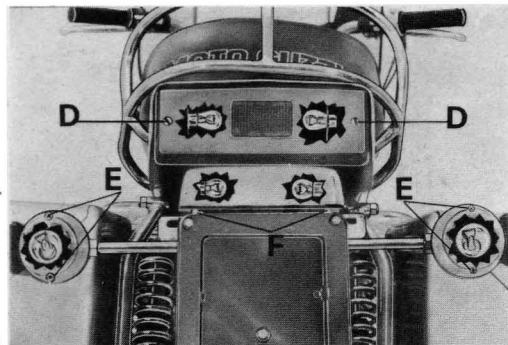

CHANGES FOR U.S.A. POLICE MODEL «LAPD»

INSTRUMENTS AND CONTROLS

(fig. 36)

- 1 Mile counter, speedometer.
- 2 Left turn indicator warning light (green).
- 3 Right turn indicator warning light (green).
- 4 «H» high beam warning light (red).
- 5 «N» neutral position warning light (orange).
- 6 «Gen» warning light indicating insufficient battery charge from generator (red).
- 7 «Oil» warning light indicating insufficient oil pressure (red).
- 8 «Park» warning light (green) indicating side stand in parking position.
- 9 «L» warning light, parking (red).
- 10 «Purs» warning light (red) indicating red lights on.
- 11 «Rad» warning light (violet) indicating radio on.
- 12 «Light» switch for additional lights.

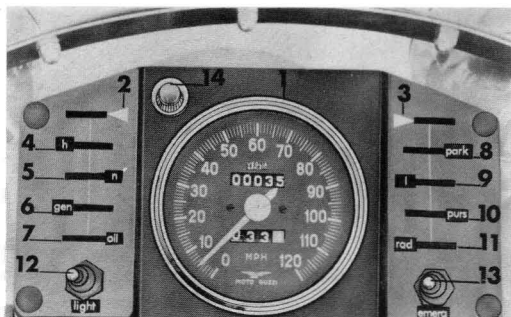

36

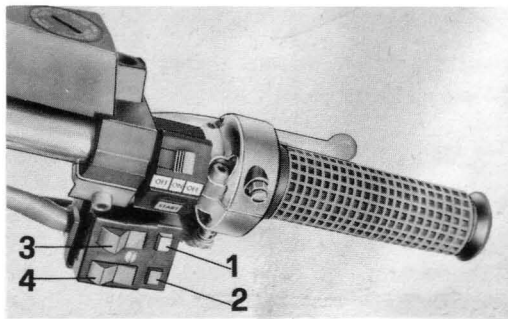

37

- 13 «Emerg» switch controlling simultaneous flashing of rear turn indicator lights (the switch controls also the flashing of warning lights «2» and «3»).
- 14 Odometer resetting.

Control buttons for radio, sirene and red lights (fig. 37)

This group is mounted on the right handlebar:

- «1» Radio control button (white).
- «2» Sirene control button (blue).
- «3» Red lights control (red).
- «4» Sirene control (blue).

Fuel taps (fig. 10)

The motorcycle fits two fuel taps under the fuel tank, rear.

Tap position:

- «A» Open (vertical).
- «R» Reserve (horizontal - see «R» on the taps).
- «C» Closed (horizontal - see «C» on the taps.)

Terminal block with fuses (fig. 11) 57

The terminal block is located on the right side of the motorcycle.

Access to the terminal block is made possible by removal of the right side cover and terminal block cover.

Key controlled

It incorporates n. 6, 16 A fuses.

- «1» Rear stop light, horns, flashing lights.
- «2» Starter motor relay, warning light «N»
- «3» Warning lights: «Oil - Gen» - Headlight: high beam, low beam and warning lights.
- «4» Rear parking lights, instrument lighting, warning light «L» rear blue lights.

Out of key control

- «5» Red lights and warning light «Purs»; additional light.
- «6» Turn indicator lights with their warning lights.

58 MAINTENANCE AND ADJUSTMENTS

Checking the fluid level in the fluid reservoir (master cylinder) for front left and rear braking circuit (fig. 38)

For a proper working of braking circuits follow these directions:

- often check the fluid level, correct level must be nearly at the rubber gaiter «E» in the fluid reservoir (master cylinder) «A». Such level must never be lower than 8 mm (.3149") under max.;
- top up periodically or whenever necessary in the fluid reservoirs (master cylinders) «A» after loosening caps «F» and removing rubber gaiters «E».

For all other maintenance and adjustments see paragraph from page 27 to page 28.

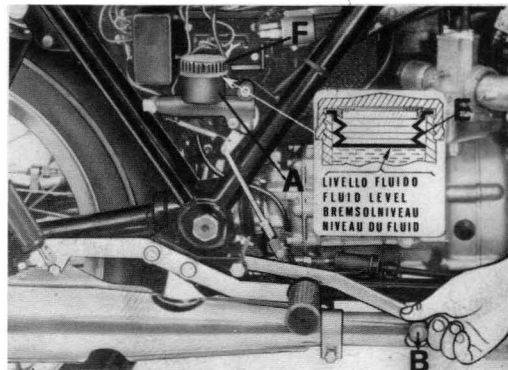

WIRING DIAGRAM

- 1 - Mile counter, speedometer (bulb 3W)
- 2 - Additional light (bulb 5W) - only on request
- 3 - High beam warning light (bulb 1,2W) «H»
- 4 - Oil pressure warning light (bulb 1,2W) «Oil»
- 5 - Neutral position warning light (bulb 1,2W) «N»
- 6 - Low beam and parking warning light (bulb 1,2W) «L»
- 7 - Generator charge warning light (bulb 1,2W) «Gen»
- 8 - Low beam (bulb 40W)
- 9 - High beam (bulb 45W)

- 10 - Turn indicator light - right, front (bulb 21W)
- 11 - Turn indicator light - left, front (bulb 21W)
- 12 - Engine starting and stopping control
- 13 - Additional light switch
- 14 - Control: Turn indicator lights, horns, flashing lights
- 15 - Horns (Consumption: 7A)
- 16 - Front brake switch
- 17 - Flashing light (Flash) relay
- 18 - Rear brake switch
- 19 - Battery
- 20 - Regulator
- 21 - Rectifier
- 22 - Alternator
- 23 - Starter motor relay
- 24 - Starter motor
- 25 - Switch on clutch control wire

- 26 - Turn indicator light - left, rear (bulb 21W)
- 27 - Rear stop light (bulbs 5/21W)
- 28 - Number plate light (bulb 5W)
- 29 - Turn indicator light (bulb 21W) left, rear
- 30 - Turn indicator lights, flasher unit
- 31 - Oil pressure switch (on the engine crankcase)
- 33 - Terminal block with fuses (16A fuses)
- 34 - 3-way connector
- 35 - 4-way connector (Amp)
- 36 - Breaker
- 37 - Coils
- 38 - Ignition switch (3 positions)
- 39 - Switch actuating rear turn indicator lights flashing
- 40 - 2-way connector
- 41 - Spark plugs
- 42 - Light switch with travel limit from position «High/Low beam» to position «Town driving light»
- 43 - Right turn indicator warning light (bulb 1,2W)
- 44 - Left turn indicator warning light (bulb 1,2W)
- 45 - Warning light indicating «Side Stand» in position «Park» (bulb 1,2W)
- 46 - Brake fluid level warning light «Brake» (bulb 1,2W)
- 47 - Fuel level warning light «Fuel» (bulb 1,2W)
- 48 - 4-way connector (Amp)
- 49 - Connection
- 50 - Brake fluid level indicator
- 51 - Fuel level indicator
- 52 - Electrovalve (2,5W)
- 53 - Coil control device
- 54 - Commutator for side stand warning light «Park» position
- 55 - Rear parking light (bulb 5/21W)

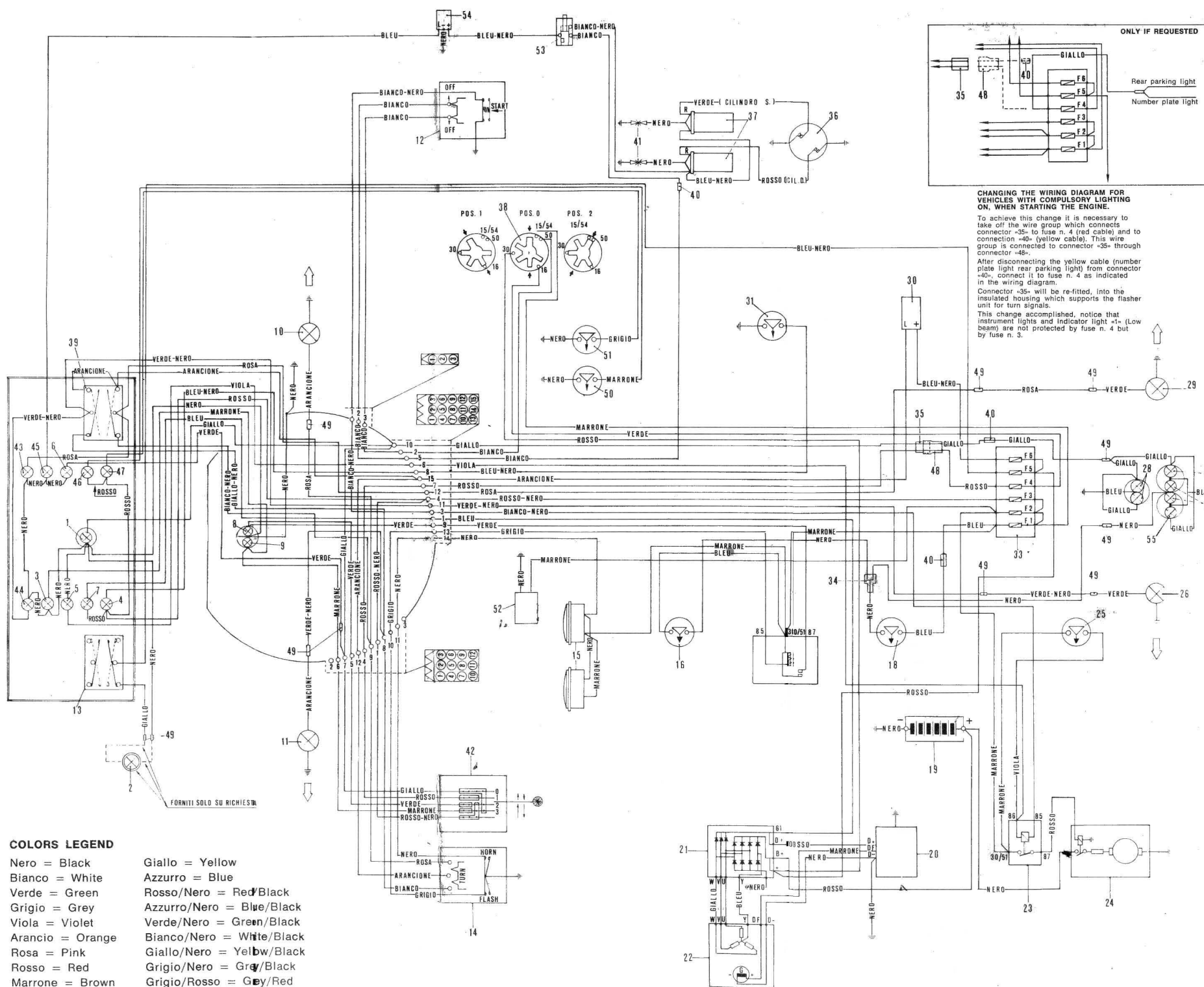

COLORS LEGEND

- | | |
|------------------|----------------------------|
| Nero = Black | Giallo = Yellow |
| Bianco = White | Azzurro = Blue |
| Verde = Green | Rosso/Nero = Red/Black |
| Grigio = Grey | Azzurro/Nero = Blue/Black |
| Viola = Violet | Verde/Nero = Green/Black |
| Arancio = Orange | Bianco/Nero = White/Black |
| Rosa = Pink | Giallo/Nero = Yellow/Black |
| Rosso = Red | Grigio/Nero = Grey/Black |
| Marrone = Brown | Grigio/Rosso = Grey/Red |

CHANGING THE WIRING DIAGRAM FOR VEHICLES WITH COMPULSORY LIGHTING ON WHEN STARTING THE ENGINE.

To achieve this change it is necessary to take off the wire group which connects connector «35» to fuse n. 4 (red cable) and to connection «40» (yellow cable). This wire group is connected to connector «35» through connector «48».

After disconnecting the yellow cable (number plate light rear parking light) from connector «40», connect it to fuse n. 4 as indicated in the wiring diagram.

Connector «35» will be re-fitted, into the insulated housing which supports the flasher unit for turn signals.

This change accomplished, notice that instrument lights and indicator light «L» (Low beam) are not protected by fuse n. 4 but by fuse n. 3.

WIRING DIAGRAM (Police model)

- 1 - Mile counter, speedometer (bulb 3W)
- 2 - Additional light (bulb 5W)
- 3 - «H» High beam warning light (bulb 1,2W)
- 4 - «Oil» Oil pressure warning light (bulb 1,2W)
- 5 - «N» Neutral position warning light (bulb 1,2W)
- 6 - «L» Low beam and parking warning light (bulb 1,2W)
- 7 - «Gen» Generator warning light
- 8 - Low beam } bulb 40/45W
- 9 - High beam }
- 10 - Turn indicator light, front/right (bulb 21W)
- 11 - Turn indicator light, left/front (bulb 21W)
- 12 - Engine starting and stopping control
- 13 - Additional light switch
- 14 - Control switch: turn indicator lights, horns, flashing
- 15 - Horn (Consumption 7A)
- 16 - Front brake switch
- 17 - Flashing light relay
- 18 - Rear brake switch
- 19 - Battery
- 20 - Regulator
- 21 - Rectifier
- 22 - Alternator
- 23 - Starter motor relay
- 24 - Starter motor
- 25 - Switch on clutch control wire
- 26 - Turn indicator light - rear/left (bulb 21W)
- 27 - Rear stop light (bulb 21W)
- 28 - Number plate and tail light (bulb 5W)
- 29 - Turn indicator light - rear/right (bulb 21W)
- 30 - Turn indicator lights flasher unit
- 31 - Oil pressure switch
- 33 - Terminal block with fuses (16A fuses)
- 34 - 3-way connector
- 35 - 4-way connector (Amp)
- 36 - Breaker
- 37 - Coils
- 38 - Ignition switch (3 positions)
- 39 - Control actuating simultaneous flashing of turn indicator lights
- 40 - 2-way connector
- 41 - Spark plugs
- 42 - Light switch with travel limit from position «High/Low beam» to position «Parking light»
- 43 - Right turn indicator warning light (bulb 1,2W)
- 44 - Left turn indicator warning light (bulb 1,2W)
- 45 - «Park» Side stand parking position warning light (bulb 1,2W)
- 46 - «Purs» Red pursuing lights warning lights (bulb 1,2W)
- 47 - «Rad» Radio warning light (bulb 1,2W)
- 48 - 4-way connector (Amp)
- 49 - Connection
- 50 - Red pursuing lights (front) - (bulb 35W)
- 51 - Control: red lights - radio - syrene
- 52 - Syrene relay
- 53 - Coil control device
- 54 - Control device for side stand warning light
- 55 - Syrenes (90W)
- 56 - Rear blue lights (bulb 5W)
- 57 - Spare fuse

COLORS LEGEND

- | | |
|------------------|----------------------------|
| Nero = Black | Giallo = Yellow |
| Bianco = White | Azzurro = Blue |
| Verde = Green | Rosso/Nero = Red/Black |
| Grigio = Grey | Azzurro/Nero = Blue/Black |
| Viola = Violet | Verde/Nero = Green/Black |
| Arancio = Orange | Bianco/Nero = White/Black |
| Rosa = Pink | Giallo/Nero = Yellow/Black |
| Rosso = Red | Grigio/Nero = Grey/Black |
| Marrone = Brown | Grigio/Rosso = Grey/Red |

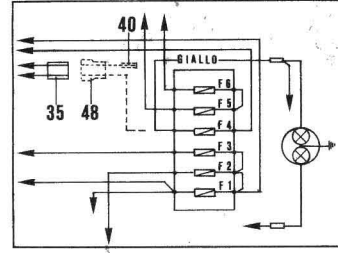
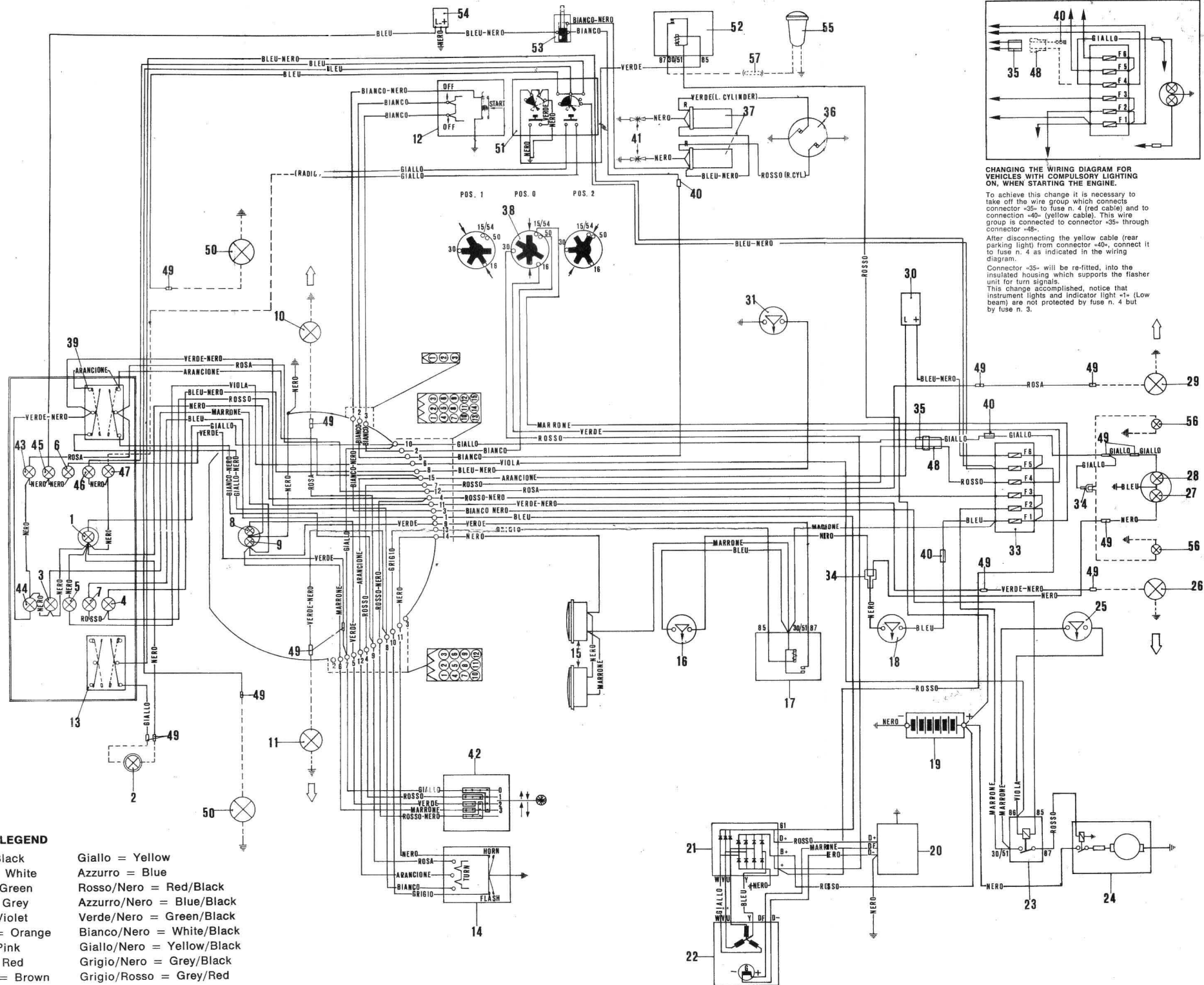

CHANGING THE WIRING DIAGRAM FOR VEHICLES WITH COMPULSORY LIGHTING ON, WHEN STARTING THE ENGINE.

To achieve this change it is necessary to take off the wire group which connects connector «35» to fuse n. 4 (red cable) and to connection «40» (yellow cable). This wire group is connected to connector «35» through connector «48».

After disconnecting the yellow cable (rear parking light) from connector «40», connect it to fuse n. 4 as indicated in the wiring diagram.

Connector «35» will be re-fitted, into the insulated housing which supports the flasher unit for turn signals. This change accomplished, notice that instrument lights and indicator light «1» (Low beam) are not protected by fuse n. 4 but by fuse n. 3.

SEIMM MOTO GUZZI S.p.A. Mandello del Lario

Reg. Imprese N. 2220 Lecco



PREMIER

MOTOR CORPORATION

HASBROUCK HEIGHTS,

NEW YORK, N.Y. 10020